



Maintenance Manual

Conversion Procedure: To convert 0U3/PXXX006X to 0U3/XXXX006X

PFA Lined Super Maxi Rail Relief Valve



CONTENTS

PFA Lined Super Maxi Rail Relief Valve

Conversion Procedure

	Introduction	3
	Maintenance Safety Precautions	4
Chapter 1	Disassemble the valve	5
Chapter 2	Assemble the valve	11
Chapter 3	Test and adjust the set pressure	17
Chapter 4	Install the anti-tamper screws	23
Appendix		27
A	Composite pressure plate: Change the O ring	29
B	Tools & Equipment	34
C	Bolt Torque Guide & Step Loading Procedure	35
D	Client Responsibilities	37
E	Data sheet: USREL149 PFA lined Super Maxi pressure only rail relief valve Part number: 0U3/PXXX006R	38
F	Data sheet: USREL197 PFA lined Super Maxi pressure only rail relief valve Part number: 0U3/XXXX006R	39
G	Data sheet: USREL185 Flanged high-pressure Super Maxi relief valve Part number breakdown	40



Introduction

PFA Lined Super Maxi Rail Relief Valve - Conversion Procedure

IMPORTANT

Read all the information and instructions before you start the procedure. Keep this manual.

WARNING: A relief valve is a spring-loaded device which can cause serious injury to personnel. Obey all the maintenance and safety precautions.

Overview

This maintenance manual contains instructions convert a PFA lined Super Maxi rail relief valve, part number series 0U3/PXXX006X to become 0U3/XXXX006X. You will need a conversion kit from Fort Vale. The kit contains:

- 1x pre-assembled pressure plate with pressure O ring
- 1x spring set
- 1x extension tube
- 1x cap
- 1x stainless steel plug
- 2x socket head screws
- 2x lead shot

The valve illustrated in this manual is part number 0U3/P165006R. It has a set pressure of 165 PSIG with Halar coated springs and a PFA lined pressure plate. The body is PFA lined with a raised face flange.

The valve will be converted to part number 0U3/0165006R. It will have a set pressure of 165 PSIG with Inconel springs and a zirconium/stainless steel composite pressure plate with a Viton A® pressure O ring. The body will not change.

NOTE: Alternative springs and O ring materials are available.

CAUTION: Make sure that the spring set pressure and the O ring material is compatible with the service conditions.

Maintenance Precautions

To prevent injury to personnel:

- be careful during maintenance.
- obey all warnings.
- use the recommended tools.
- use the applicable PPE.

To prevent damage to the valve:

- use the recommended tools to do the maintenance and to test the valve.
- obey the recommended bolting sequence and Step Loading Procedure when you remove and install the valve (see Appendix C: Bolt Torque Guide & Step Loading Procedure).
- read Client Responsibilities (see Appendix D).
- use genuine Fort Vale spare parts.

If you have a problem that you cannot solve using this manual, please contact us.

Tools & Equipment

You will need general workshop equipment and hand tools and some special tools to do relief valve maintenance. Please refer to Appendix B: Tools & Equipment

Replacement Parts

Identify your relief valve - the part number series will be marked on the valve cap. Please contact Fort Vale to order new seal kits and replacement parts. Install only genuine spare parts.

WARNING: If you install a replacement part that is not a genuine Fort Vale part, there is a risk of:

- injury to personnel.
- valve malfunction.
- permanent damage to the valve or tank.



Maintenance Manual

Maintenance Safety Precautions



Important Safety Notice

WARNING: Vessels and systems operate under pressure and can contain dangerous cargo (liquid and gas) that can cause death or serious injury to personnel.

Precautions

Before you remove a valve from the vessel/system, you must:

- do a Hazard Identification and Risk Assessment.
- make sure the vessel/system is empty (liquid and gas).
- make sure the vessel and valves have been cleaned correctly.
- make sure the vessel has been certified safe for human entry.
- make sure that the vessel/system pressure is at zero. When all the vessel/system pressure is released, use an approved method to release all residual pressure before you loosen the fasteners.
- read the SDS (Safety Data Sheet) for the last cargo and obey the recommended precautions.
- use the applicable PPE (Personal Protection Equipment) for the cargo and operating conditions.

Approved Person

You must be an “approved person” to do valve maintenance and testing. An approved person:

- knows the function of the valve.
- knows how the valve is assembled, installed and operated.
- knows the operation limits of the valve.
- has experience and qualifications related to valve maintenance and testing.
- knows and obeys all the related in-company and regional/national regulations.

After maintenance

When you have completed the maintenance, you must do an approved leak test to the valve before you install it onto the vessel.



CHAPTER 1

Disassemble the valve

PFA Lined Super Maxi Rail Relief Valve - Conversion Procedure

This chapter contains instructions to fully disassemble the valve.



Step 1. Identify the valve. The part number is laser marked on the cap. If you are unsure please contact Fort Vale. **WARNING: Relief valves are spring-loaded and can cause serious personal injury. Obey all the instructions and wear eye protection during this procedure.**



Step 2. Use a sharp-edged tool to detach the stainless steel plug.



Step 3. Remove the stainless steel plug. Keep the plug.



Step 4. Use a sharp-edged tool to remove the anti-tamper seal.

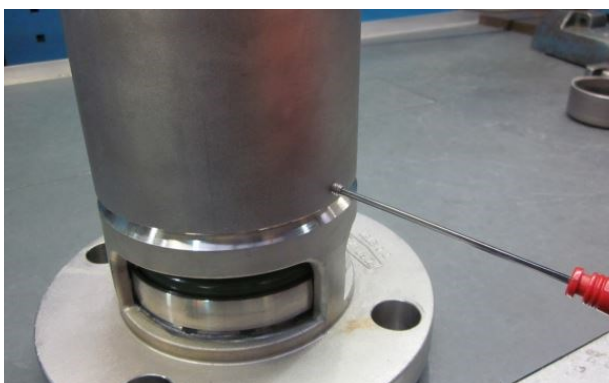

Step 5. Use a 3/32" hex key to remove the 3/16" BSW socket head screw.

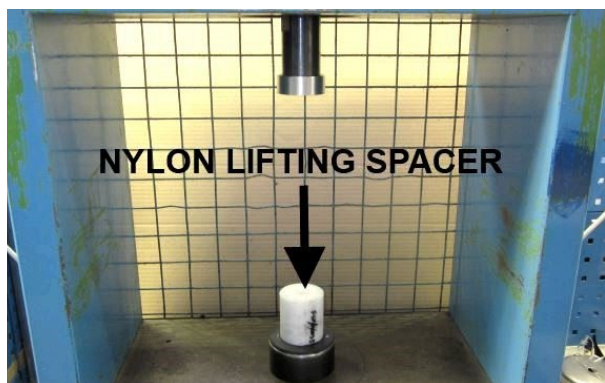

Step 6. Select the nylon lifting spacer, part number FIX/A/0035, and install it onto a bench press with a minimum 1 tonne load.

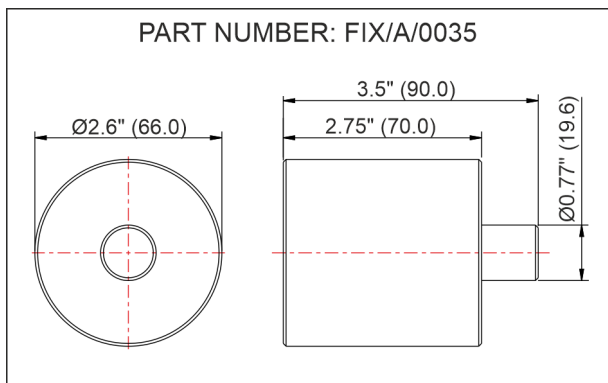

Step 7. Dimensioned drawing of the nylon lifting spacer.



Step 8. Install the valve onto the nylon lifting spacer. Make sure that the valve is central on the spacer.



Step 9. Select the cap tightening tool, part number FIX/A/0034. Engage the two pins on the cap tightening tool into the two blind holes of the top cap.



Step 10. Make sure that the cap tightening tool is installed correctly on the top cap.



Step 11. Apply pressure onto the top cap tightening tool until the spring is compressed sufficiently so that the valve body is free to turn. Then turn the valve body clockwise until it is disassembled from the top cap. **WARNING: Make sure that you lock the press before you start to unscrew the valve.**



Step 12. When the valve and the cap are disassembled, unlock the press and gradually retract the press to release the spring load. **WARNING: Be careful when you retract the press. Make sure that the spring is fully decompressed before you remove the ram.**



Step 13. When the spring is fully decompressed, retract the ram fully.

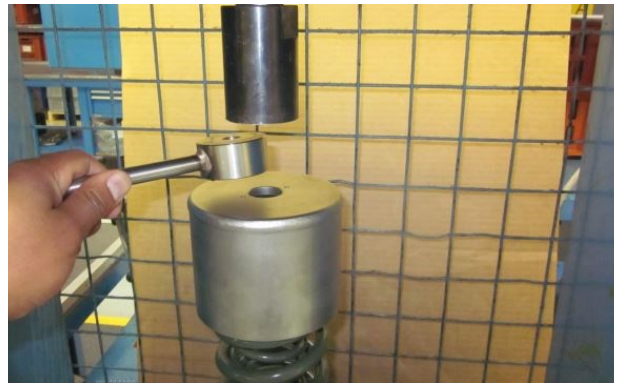

Step 14. Remove the cap tightening tool.



Step 15. Remove the top cap and discard it.



Step 16. Remove the springs and discard them.



Step 17. Remove the valve body and pressure plate to a clean work bench.



Step 18. Use a sharp-edged tool to detach the retaining ring clip. If the valve does not have a ring clip, go to Step 20.



Step 19. Remove the retaining ring clip.



Step 20. Remove the pressure plate and identify the type.

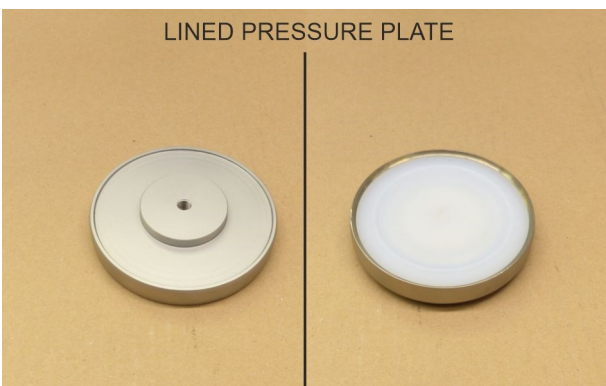

Step 21. If it is a lined pressure plate, discard it. Use the composite pressure plate assembly supplied in the conversion kit for the valve assembly procedure.



Step 22. If it is a composite pressure plate assembly and it is necessary to change the O ring, refer to Appendix A: Composite pressure plate - change the O ring.



Step 23. Examine the PFA lined valve body for signs of damage. Look carefully at the pressure plate sealing face and the gasket sealing face. If there is damage, contact Fort Vale.
The disassembly procedure is complete.



CHAPTER 2

Assemble the valve

PFA Lined Super Maxi Rail Relief Valve - Conversion Procedure

This chapter contains instructions to fully assemble the valve.

For this part of the procedure, you will need a conversion kit that is available from Fort Vale. Make sure that the spring and the O ring material in the conversion kit are compatible with the service conditions.



Step 24. Select the conversion kit. In this example, the part number is 0U3/0165K. This kit contains: pressure plate assembly with Viton O ring; 165 PSIG spring set; body extension tube; valve top cap; stainless steel plug; 2x socket head screw; 2x 1/8" lead shot.
CAUTION: Make sure the spring setting and pressure O ring material is compatible with the service conditions.



Step 25. Keep all the parts in a clean area until you are ready to install them.
NOTE: You do not need to disassemble the pressure plate assembly unless there is damage. If there is damage to the O ring, refer to Appendix A: Composite pressure plate - change the O ring.



Step 26. Make sure that the seal face of the body is clean and that there is no damage. If there is damage, contact Fort Vale.



Step 27. Install the pressure plate into the body. If the valve has a retaining ring clip, go to Step 28. If there is no ring clip, go to Step 30.



Step 28. Squeeze the retaining ring clip to help you install it. Install the ring clip into the body and push it into the groove. Make sure it is fully installed around the circumference. **CAUTION:** Be careful - spring-loaded part.



Step 29. The retaining ring clip correctly installed in the groove.



Step 30 Put a mark where the body is drilled for the anti-tamper screw. This will help when you lock the valve at the end of the procedure. It is important that you do not drill in the same position.



Step 31. Apply thread lubricant that is compatible with stainless steel on the thread of the extension tube. Lubrication helps the threads to engage between the body and the tube.



Step 32. Install the extension tube onto the valve body and turn the extension tube clockwise to engage the threads. Continue to turn the extension tube until it is fully engaged and there are no threads visible on the valve body.



Step 33. Install the springs into the valve body. Keep the orientation of the inner and the outer spring as shown.



Step 34. Apply thread lubricant that is compatible with stainless steel on the thread of the top cap. Lubrication helps the threads to engage between the body and the cap.



Step 35. Install the top cap onto the springs. Make sure that the springs engage in the groove inside the top cap.



Step 36. To complete the assembly procedure, move the valve to a bench press with a minimum 1 tonne load.
WARNING: Relief valves are spring-loaded and can cause serious personal injury. Obey all the instructions and wear eye protection during this procedure.

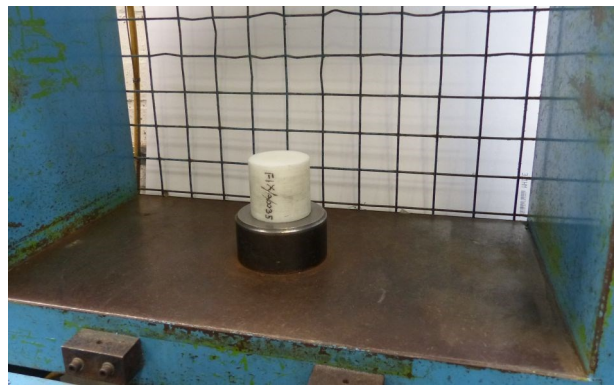

Step 37. Select the nylon lifting spacer, part number FIX/A/0035, and install it onto the bench press.

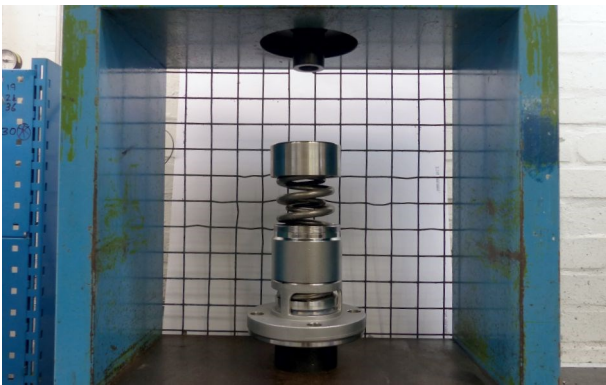

Step 38. Make sure that the top ram is retracted to allow enough space to accept the valve height. Install the valve onto the nylon lifting spacer. Make sure that the valve is central on the spacer.

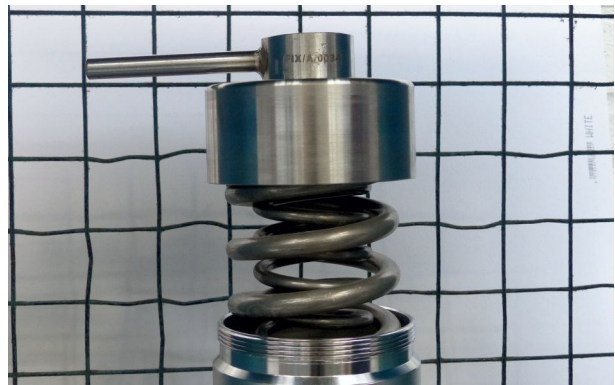

Step 39. Select the cap tightening tool, part number FIX/A/0034. Locate the two pins on the cap tightening tool into the two blind holes of the top cap. Make sure that the cap tightening tool is located correctly on the top cap.



Step 40. Make sure that the valve assembly is centrally aligned to the ram. Apply pressure slowly onto the top cap to compress the spring. **CAUTION: Align the body with the cap to prevent cross-threading.**

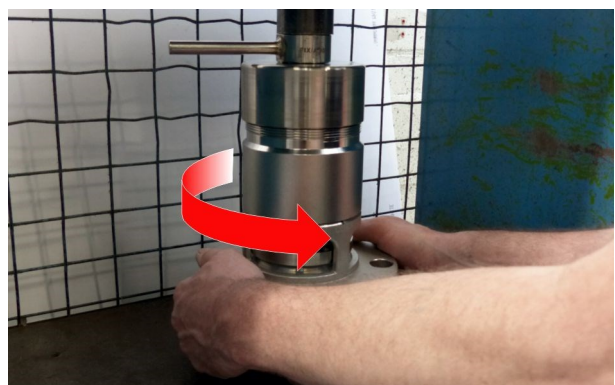

Step 41. Stop the press when there is a gap of approx. 1/8" (2-3mm) between the top cap and the valve body. Lift the valve body and rotate it anti-clockwise to engage the threads between the valve body and the top cap. Continue to screw the body fully into the cap until there are no threads visible. **WARNING: Make sure that you lock the press.**



Step 42. When the top cap and valve are fully engaged, release pressure from the top ram.

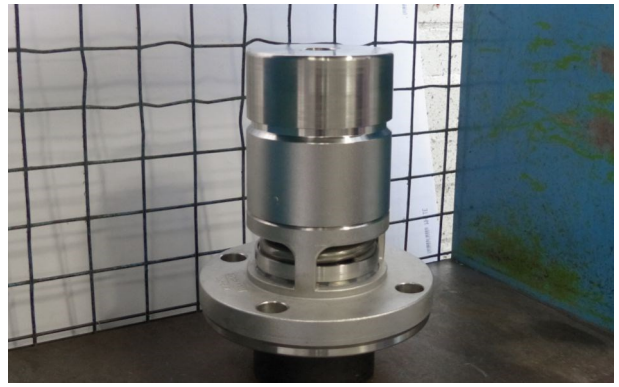

Step 43. Remove the cap tightening tool. The assembly procedure is complete.

NOTE: You must do the pressure test and adjustment procedure before you install the valve onto the tank. Refer to Chapter 3.



CHAPTER 3

Test and adjust the set pressure

PFA Lined Super Maxi Rail Relief Valve - Conversion Procedure

This chapter contains instructions to test the set pressure of the relief valve and to make small adjustments to get the correct set pressure.

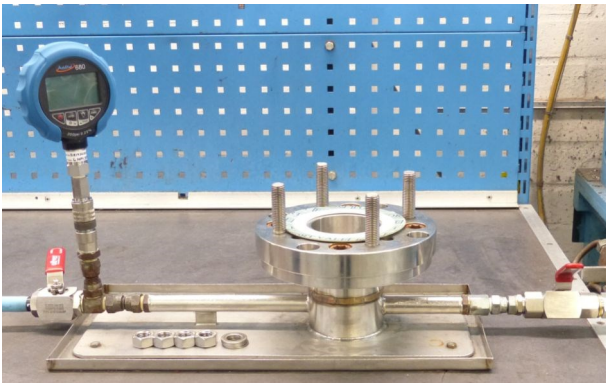

Step 44. Do a pressure test procedure that obeys AAR standards:
The photo shows a typical pressure test rig. You can buy a test rig from Fort Vale.

WARNING: You must be an approved person to test and set relief valves. Spring-loaded valves can cause serious personal injury.

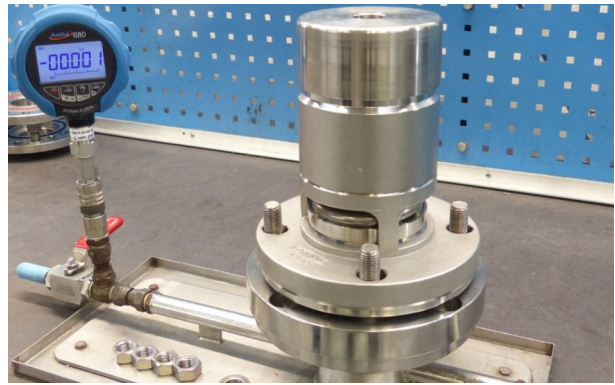

Step 45. Align the 4 holes on the inlet flange of the valve with the 4 hole drilling on the test rig flange.

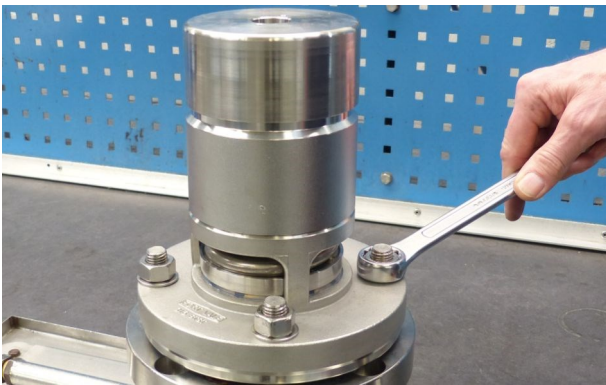

Step 46. Install 4x compatible washers and bolts. Tighten the nuts in a diametrically opposite sequence.



Step 47. Select the leak test ring, part number FIX/A/0047. Install the leak test ring onto the relief valve. Move the ring down the valve body so that it touches the flange.

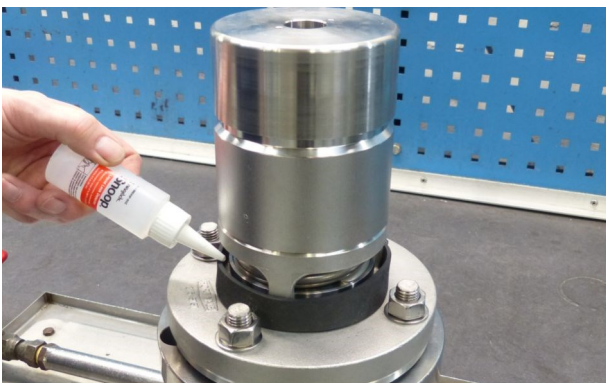

Step 48. PRESSURE TEST:
Apply leak-detection fluid between the pressure plate and the leak test ring.

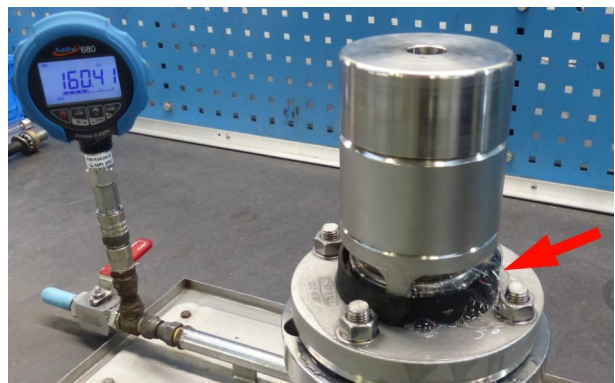

Step 49. Apply pressure up to the set pressure of the valve and look for bubbles around the pressure plate. Note the pressure at which the bubbles start to occur. This indicates the set pressure of the valve. Release the pressure. Do the Pressure Adjustment procedure to get the correct set pressure, Step 50 to Step 61.



Step 50. PRESSURE ADJUSTMENT:

To adjust the valve to the correct set pressure, select the relief valve adjusting tool part number FIX/A/0015/23. Use a 1½" (38mm) A/F spanner to adjust the jacking nut. NOTE: The procedure that follows assumes that the set pressure of the valve is 165 PSI.

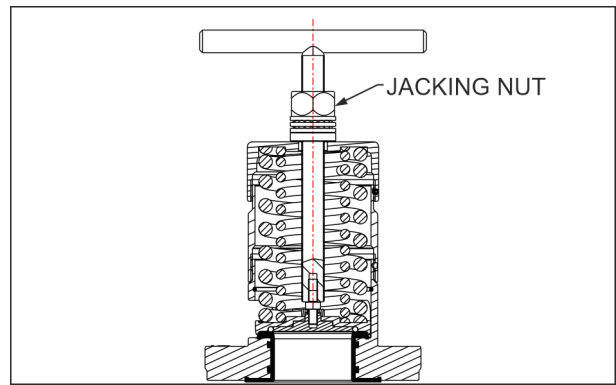

Step 51. The adjustment tool has a 5/16" UNF female connection that engages onto the 5/16" UNF stud on the pressure plate. When the tool is installed onto the relief valve, you can tighten the jacking nut to lift the pressure plate off the valve sealing face. You can then turn the valve cap to adjust the spring load.

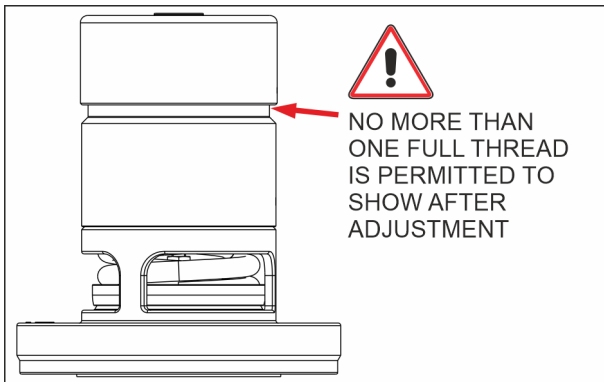

Step 52. WARNING: When you turn the valve cap, A MAXIMUM OF ONE FULL THREAD is permitted to show. The cap is holding the spring load. If you turn the cap more, there is a risk of serious injury.



Information

Step 53. PRESSURE SETTING TOLERANCE:
 The tolerance for the set pressure/Start to Discharge (STD) is ±3%.
 For a set pressure of 165 PSI:
 Minimum STD pressure = 160.1 PSI
 Maximum STD pressure = 169.95 PSI

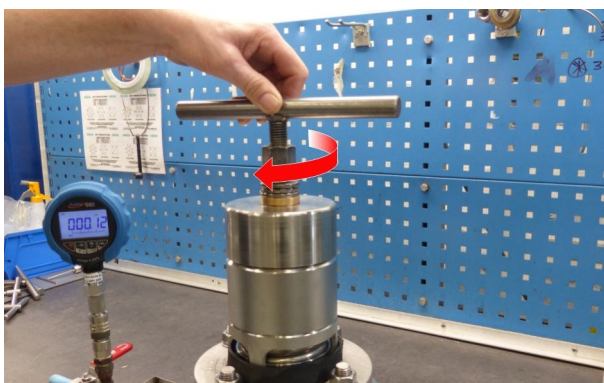

Step 54. With the jacking nut at the top of the thread, install the relief valve adjusting tool through the hole in the top cap. Engage the female threaded end of the tool onto the pressure plate stud and turn the tool clockwise to tighten it. Make sure the tool is fully engaged. **WARNING:** Make sure that all pressure has been released and that the air supply is off.



Step 55. When the tool is fully engaged with the pressure plate, hold the tee bar and use a 1½" (38mm) A/F spanner to tighten the brass jacking nut. This will lift the pressure plate off the sealing face, which allows the cap to turn. **WARNING:** Make sure that you turn the cap only. Be careful not to turn the extension tube. There is a risk of serious injury if you turn the cap and the tube too much.

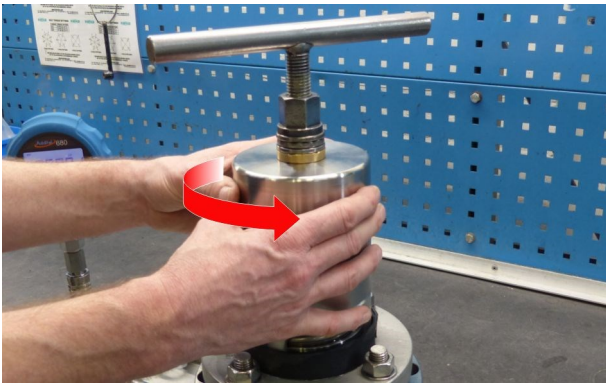

Step 56. PRESSURE TOO HIGH: If the test pressure result was higher than 165 PSI, turn the cap approx. ¼ turn anti-clockwise. Loosen the jacking nut to re-seat the pressure plate. Unscrew and remove the adjustment tool. Do the pressure test again, Step 48 to Step 49.

WARNING: Do not turn the cap too much, a maximum of one full thread is permitted to show. If you turn the cap more, there is a risk of serious injury.

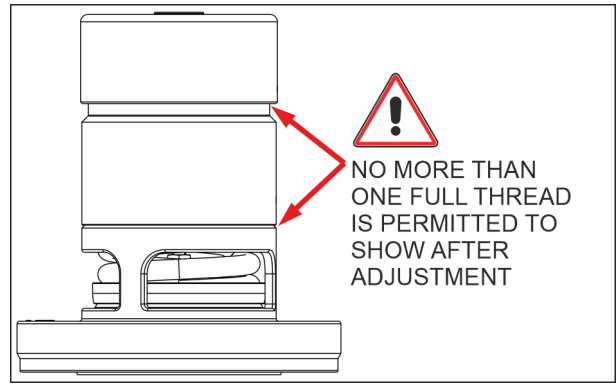

Step 57. If the pressure is still too high when one thread shows below the cap, use the adjustment tool and turn the extension tube approx. ¼ turn anti-clockwise. Remove the tool. Do the pressure test again, Step 48 to Step 49.

WARNING: Do not turn the extension tube too much, a maximum of one full thread is permitted to show. If you turn the tube more, there is a risk of serious injury. Be careful not to turn the cap more.

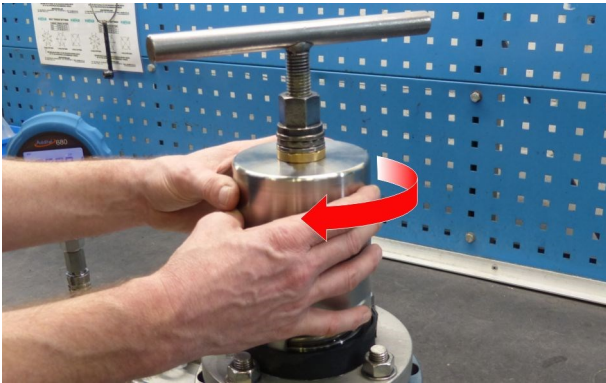

Step 58. PRESSURE TOO LOW: If the test pressure result was lower than 165 PSI, turn the cap approx. ¼ turn clockwise. Loosen the jacking nut to re-seat the pressure plate. Unscrew and remove the adjustment tool. Do the pressure test again, Step 48 to Step 49.

WARNING: Do not turn the cap too much, a maximum of one full thread is permitted to show. If you turn the cap more, there is a risk of serious injury.

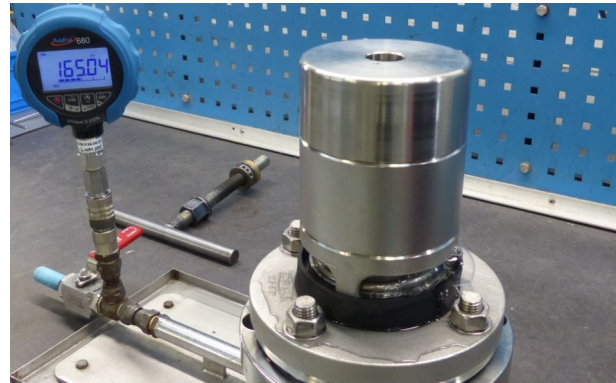

Step 59. Do the pressure adjustment and the pressure test procedures until you get the correct set pressure. When the set pressure is satisfactory, do the Re-Seal Pressure Test, Step 62 to Step 63.



Step 60. TROUBLESHOOTING: If you cannot get the correct set pressure when one thread shows below the cap and below the extension tube: Disassemble the valve and turn the spring through 180°. Assemble the valve and do the pressure test and adjustment procedures. Refer to the related chapters for instructions.



Step 61. TROUBLESHOOTING: If turning the spring does not solve the problem, disassemble the valve and install a new spring. Assemble the valve and do the pressure test and adjustment procedures. Refer to the related chapters for instructions.

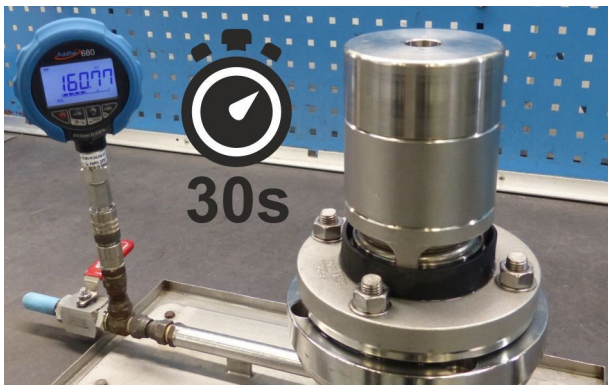

Step 62. RE-SEAL PRESSURE TEST:
Pressurize the valve up to the set pressure and stop the air supply. Apply leak detection fluid and monitor the relief valve. Note the pressure at which there is no leakage for 30 seconds. Leakage is identified by small bubbles around the pressure plate. This is the re-seal pressure.



Information

Step 63. RE-SEAL PRESSURE TOLERANCE:
The maximum tolerance for the re-sealing pressure/vapor tight pressure (VTP) is 80% of the set pressure. For a set pressure of 165 PSI: minimum re-seal pressure/VTP = 132 PSI.



Information

Step 64. When the valve set pressure/re-seal pressure is satisfactory, do the pressure test and re-seal pressure test again to make sure you get a satisfactory result again. If the 2nd results are satisfactory, release the pressure from the test rig.



Step 65. Use a thermometer and measure the surface temperature of the valve. Make sure that the temperature agrees with the AAR tolerances.



Step 66. Remove the leak test ring. Dry the valve and the test rig.
CAUTION: Make sure that all pressure is released and the supply pressure is off before you remove the valve.



Step 67. Remove the valve from the test rig. Install the stainless steel plug.
NOTE: You must install the anti-tamper screws to lock the valve before you install the valve onto a tank. Refer to Chapter 4.



CHAPTER 4

Install the anti-tamper screws

PFA Lined Super Maxi Rail Relief Valve - Conversion Procedure

This chapter contains instructions to lock the relief valve when all the test results are satisfactory.

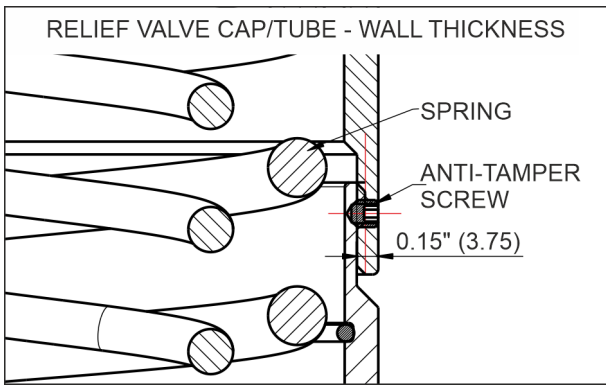

Step 68. INSTALL THE ANTI-TAMPER SCREWS: The cap and extension tube are locked to the valve body with an anti-tamper screw filled with lead shot. Note the wall thickness. **CAUTION:** It is important not to drill fully through the cap/tube and body because it can cause damage to the spring.

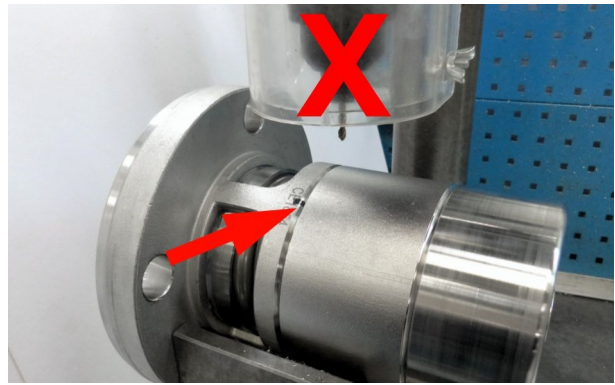

Step 69. Put the valve on a V block on a pedestal drill. Look for the mark on the valve where the body has been drilled. Do not drill near the same location. Turn the body to the next port.

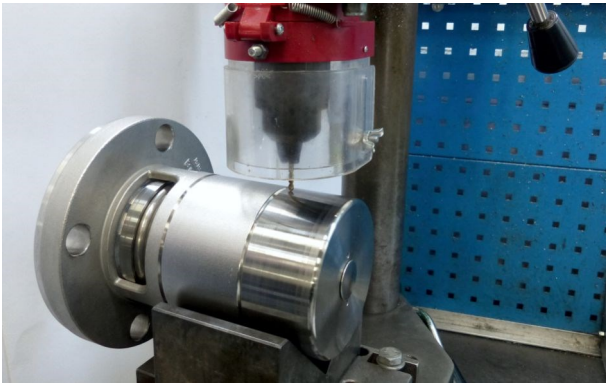

Step 70. Use a No 22 (4mm) drill and make a hole 0.2" (5mm) from the edge of the cap. Drill to a depth of 0.2" (5mm). **CAUTION:** Do not drill to a depth of more than 0.2" (5mm) to prevent damage to the spring.

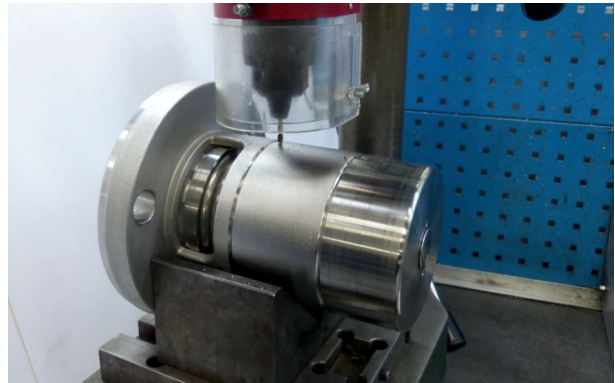

Step 71. Move the valve so that you can drill the extension tube. Make a hole 0.2" (5mm) from the edge of the extension tube. Drill to a depth of 0.2" (5mm). **CAUTION:** Do not drill to a depth of more than 0.2" (5mm) to prevent damage to the spring.

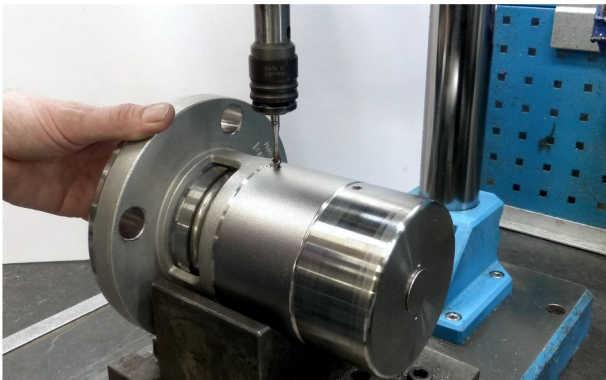

Step 72. Use a 3/16" BSW tap and tap the both of the holes to a depth of 0.14" (3.5mm). **CAUTION:** Do not tap to a depth of more than 0.14" (3.5mm) to prevent damage to the spring.



Step 73. Clean the holes using compressed air.

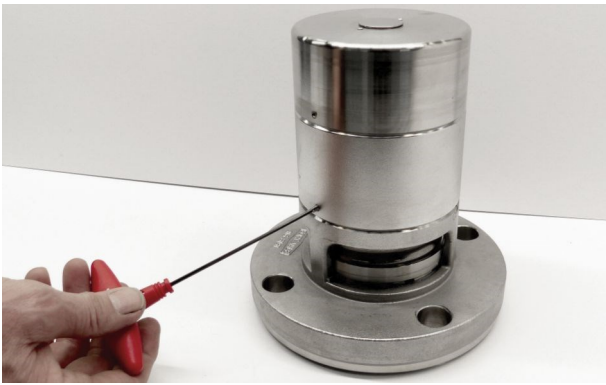

Step 74. Install a 3/16" x 3/16" long socket head screw into each hole. Use a 3/32" hex key to turn each screw until it is recessed.

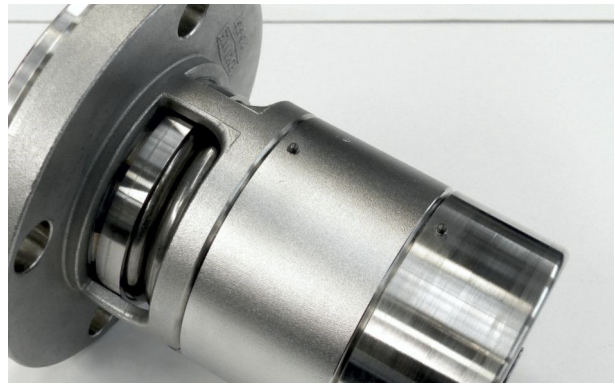

Step 75. Put a 1/8" lead shot into the top of both screws.



Step 76. Using a pin punch, lightly tap the pin punch with a hammer to compress the shot and seal the screw. Seal both screws. **CAUTION: Do not use too much force. Too much force will cause damage to the valve.**



Step 77. The procedure is complete. If you do not wish to install the valve immediately, seal the valve in a clean plastic bag.



APPENDIX

PFA Lined Super Maxi Rail Relief Valve

Conversion Procedure

A	Composite pressure plate: Change the O ring	29
B	Tools & Equipment	34
C	Bolt Torque Guide & Step Loading Procedure	35
D	Client Responsibilities	37
E	Data sheet: USREL149 PFA lined Super Maxi pressure only rail relief valve Part number: 0U3/PXXX006R	38
F	Data sheet: USREL197 PFA lined Super Maxi pressure only rail relief valve Part number: 0U3/XXXX006R	39
G	Data sheet: USREL185 Flanged high-pressure Super Maxi relief valve Part number breakdown	40



Step 78. COMPOSITE PRESSURE PLATE: CHANGE THE O RING

Use a 1/2" (13mm) spanner and unscrew the 5/16" UNF full nut to the end of the stud. Do not remove the nut. If the stud unscrews from the pressure plate when you loosen the nut, go to Step 94 - REPLACE THE STUD.



Step 79. Use a plastic mallet to hit the full nut to disengage the pressure plate assembly. **CAUTION: Hold the pressure plate assembly. Do not let it drop. Do not use a metal hammer. Be careful not to cause damage to the stud.**



Step 80. Remove the full nut and washer.

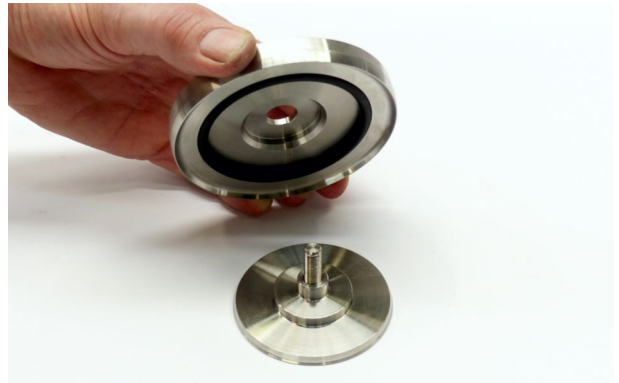

Step 81. Lift the outer pressure plate off the inner pressure plate. Make sure that the stud is not loose. **NOTE:** Do not remove the stud unless it is damaged. If the stud is not damaged, go to Step 82. If the stud is damaged, go to Step 94 - REPLACE THE STUD.



Step 82. Remove the O ring and discard it. **CAUTION: Be careful not to cause damage to the O ring groove or the pressure plate. Damage will cause the valve to malfunction.**



Step 83. Clean the outer pressure plate. Examine it for damage. If there is any damage, contact Fort Vale.



Step 84. Clean the inner pressure plate. Examine it for damage. If there is any damage, contact Fort Vale.



Step 85. Examine the new O ring for signs of damage. Do not fit a damaged O ring, it will cause the valve to malfunction.



Step 86. Install the O ring into the outer pressure plate. Push the O ring around the circumference to install it into the groove.

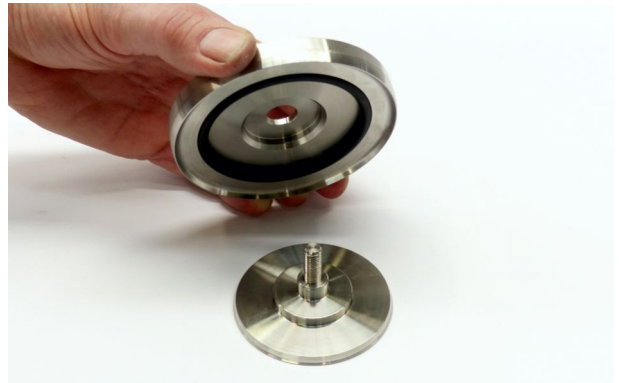

Step 87. Put the outer pressure plate and O ring over the inner pressure plate.

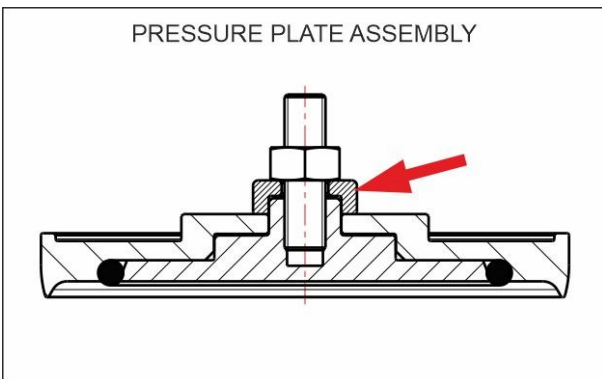

Step 88. Note the correct orientation of the retaining washer.



Step 89. Install the retaining washer. Apply thread adhesive to the thread of the stud.



Step 90. Install the nut and tighten it hand-tight.



Step 91. Make sure that the O ring is correctly installed. The O ring must be held equally around its circumference by the inner pressure plate.

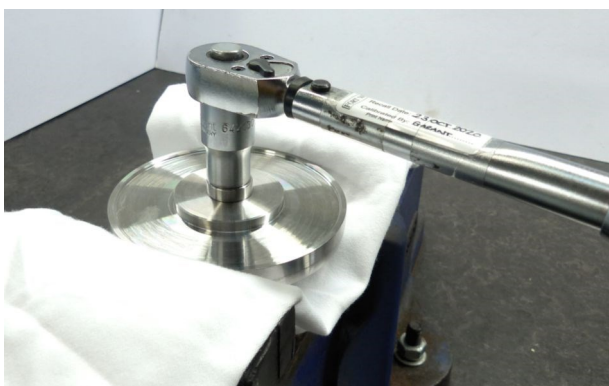

Step 92. Put the pressure plate assembly into a soft jaws vice. Torque the nut to 15 ft.lbs (20 Nm). **CAUTION: Use a clean cloth to prevent damage to the edges of the pressure plate.**



Step 93. Remove the pressure plate assembly from the vice. The procedure is complete. Refer to Chapter 2 - Assemble the valve.



Step 94. REPLACE THE STUD: Use a 1/2" (13mm) spanner to loosen the 5/16" UNF nut on the pressure plate assembly.



Step 95. Remove the 5/16" UNF stud and nut.

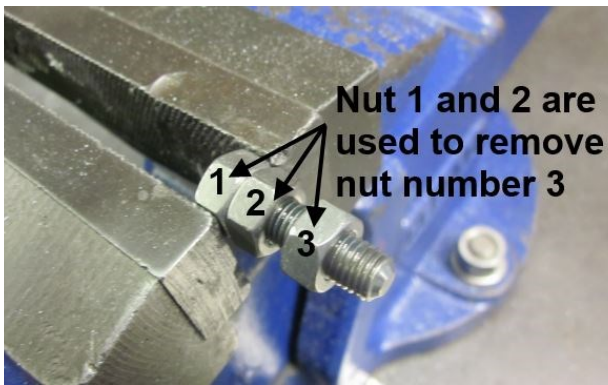

Step 96. Use a 1/2" (13mm) spanner to remove the 5/16" nut from the stud. If you cannot move the nut, use 2x 5/16" nuts as shown to prevent damage to the thread: Hold nut 1 in a vice and tighten nut 2. Unlock nut 3 by turning it clockwise and anti-clockwise. Remove nut 3.



Step 97. Use a wire brush to clean any remaining adhesive from the stud. Examine the thread on the stud. If there is damage, replace the stud.



Step 98. To disassemble the inner and outer pressure plate, insert a 3/16" diameter rod into the hole in the inner pressure plate. Gently tap the rod with a hammer. Remove the retaining washer. **CAUTION: Take care not to cause damage. Do not let the inner pressure plate fall.**



Step 99. Disassemble the inner pressure plate, outer pressure plate and retaining washer.



Step 100. Clean the threaded hole with compressed air. Apply thread adhesive to the thread of the inner pressure plate.



Step 101. Install the 5/16" UNF stud and tighten it. Make sure the stud is fully installed to the bottom of the hole.

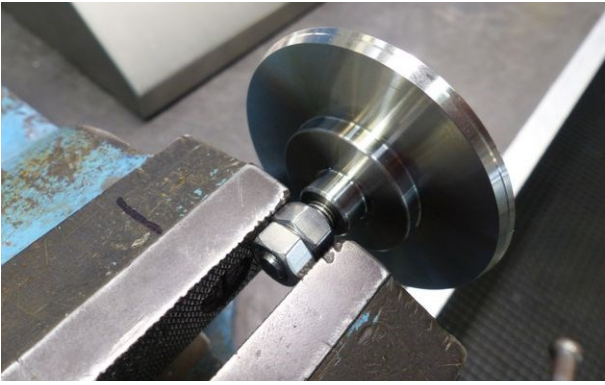

Step 102. It is important to fully tighten the stud/pressure plate assembly: Install 2x 5/16" nuts onto the stud. Hold the nuts in a vice to avoid damage to the thread. Tighten the pressure plate by hand. Remove the assembly from the vice and remove the 2x nuts. Go to Step 82 and complete the assembly procedure.



General Tools & Equipment

You will need the following general tools to do maintenance on a PFA lined Super Maxi Relief Valve:

Scribe/small screwdriver

3/32" hex key

Compressed air - dry & filtered

Clean cloth

Thread lubricant (compatible with stainless steel) e.g. Rocol®

Leak detection fluid

Thread adhesive

15/16" (24mm) A/F spanner

1½" (38mm) A/F spanner

½" (13mm) torque spanner

⅛" lead shot

3/16" diameter rod

Pin punch

Hammer

Plastic mallet

Pedestal drill with No.22 (4mm) drill and 3/16" BSW tap

Bench press - 1 tonne load minimum

WARNING: Spring-loaded valves can have a load of up to 1 tonne. Make sure that your press is compatible with this load.

Surface temperature measuring device (calibrated)

Special Relief Valve Maintenance Tools

You will need the following special tools to do maintenance on a PFA lined Super Maxi Relief Valve. You can buy all the special tools from Fort Vale.

Cap tightening tool, part number FIX/A/0034

Nylon lifting spacer, part number FIX/A/0035

Leak test ring, part number FIX/A/0047

Relief valve adjusting tool, part number FIX/A/0015/23

Relief valve test rig - see NOTE below.

NOTE: We recommend that you use a Fort Vale Relief Valve Test Rig. However, if you already have a test rig, we recommend that you obey these precautions:

Test Rig Precautions

Compressed air supply conditions:

- The compressed air must be clean, dry and filtered.
- Regularly clean and do the servicing of the filters, downstream pipework and compressor.
- The compressed air supply pipes must have a minimum internal diameter of 3/16" (4mm).
- The compressed air supply pressure must be a minimum of 15 PSI (1 Bar) higher than the test pressure of the valve.

Test rig pressure/vacuum gauges:

- Calibrate the gauges to AAR requirements.
- Obey the maximum allowable pressure on the gauge(s) and do not apply more than the allowed pressure.
- Do not apply pressure to a vacuum gauge.
- The pressure and vacuum gauges and the valve test port must not be more than 9.75" (250mm) away from each other.



Bolt Torque Guide & Step Loading Procedure (US)

Installation & Operating Instructions

Flange Bolting

CAUTION: Weld-distortion and too much tightening force will cause damage to a flange.

It is important not to cause damage to weld-in flanges and mating flanges. If a flange is damaged it will not give a satisfactory seal when a gasket and secondary mating flange is installed.

Bolt-stress can decrease after initial tightening. The cause can be deformation of the gasket material, particularly with soft materials such as a CNAF/PTFE envelope gasket.

Best procedure recommends that, after initial bolting, the flange joint is tightened again after a period of time. Most gasket manufacturers advise a period of 24 hours. ASME PCC-1-2000 GUIDELINES FOR PRESSURE BOUNDARY BOLTED FLANGE JOINT ASSEMBLY advises a minimum period of 4 hours.

Bolt torque calculations are based on a flat flange to within 0.006".

Recommended bolt torque values will be reduced if a lubrication is used.

Bolt Torque

Bolt Torque Values

Fort Vale bolt torque values are given as a reference guide only and are based on:

- The use of a CNAF/PTFE gasket.
- Unlubricated fasteners.
- A flange flat to within 0.006".

CAUTION: If you use a different gasket material, a lubricant, a flange with distortion, you must re-calculate the torque value.

Bolt Torque Procedure

To install flanged parts correctly:

- Examine the mating flange of the part.
- If the flange is marked with a torque value, obey that torque value.
- If there is no torque value marked on the mating flange, obey the bolt torque values given in Table BT1.
- Tighten the bolts evenly in sequence. See Figure BT1.
- Obey the Step Loading Procedure (ASME PCC-1-2000). See next page.

Table BT1

THREAD	TORQUEVALUE
3/8"	22 ft.lbs
1/2"	48 ft.lbs
5/8"	60 ft.lbs

Figure BT1

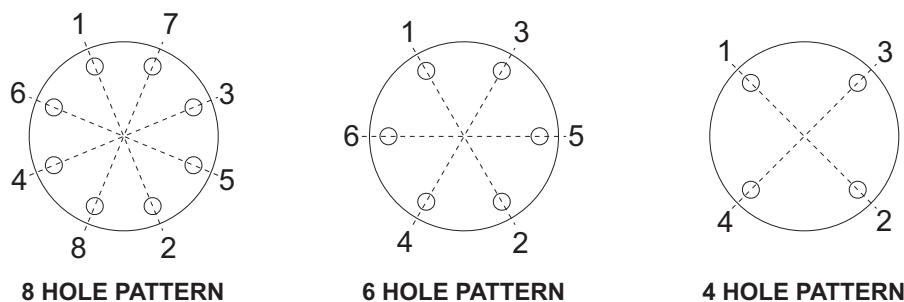



Bolt Torque Guide & Step Loading Procedure (US)

Installation & Operating Instructions

Step Loading Procedure

To install flanged parts correctly, obey the Step Loading Procedure extract from ASME PCC-1-2000:

Install

Hand tighten, then “snug up” to 10 ft.lbs to 20 ft.lbs (not to exceed 20% of Target Torque). Check flange gap around circumference for uniformity. If the gap around the circumference is not reasonably uniform, make the appropriate adjustments by selective tightening before proceeding.

Round 1

Tighten to 20% to 30% of Target Torque. Check flange gap around circumference for uniformity. If the gap around the circumference is not reasonably uniform, make the appropriate adjustments by selective tightening before proceeding.

Round 2

Tighten to 50% to 70% of Target Torque. Check flange gap around circumference for uniformity. If the gap around the circumference is not reasonably uniform, make the appropriate adjustments by selective tightening before proceeding.

Round 3

Tighten to 100% of Target Torque. Check flange gap around circumference for uniformity. If the gap around the circumference is not reasonably uniform, make the appropriate adjustments by selective tightening before proceeding.

Round 4

Continue tightening the bolts, but on a rotational clockwise pattern until no further nut rotation occurs at the Round 3 Target Torque value. For indicator bolting, tighten bolts until the indicator rod retraction readings for all bolts are within the specified range.

Round 5

Time permitting, wait a minimum of 4 hr and repeat Round 4; this will restore the short-term creep relaxation/embedment losses. If the flange is subjected to a subsequent test pressure higher than its rating, it may be desirable to repeat this round after the test is completed.



Client Responsibilities - Valves & Ancillaries for AAR Installation, Operation & Maintenance Instructions

Compatibility

Make sure that the function and technical specification of the valve/ancillary is compatible with the vessel service conditions and the cargo. This includes, but is not limited to:

- dimensions
- pressure/vacuum setting
- air/gas/liquid flow capacity
- maximum allowable working pressure
- test pressure
- minimum/maximum design temperatures
- materials of construction.

Maintenance

Fort Vale valves and ancillaries have a long life if you use them correctly in compatible service conditions. It is not necessary to lubricate the parts, but we recommend that you obey the precautions that follow:

Visual checks at regular intervals:

1. Examine the valve to make sure there is no damage, wear or corrosion.
2. Examine the valve and adjacent area to make sure there is no leakage of cargo.
3. Examine the fasteners to make sure they are not loose.
4. Make sure the valve operates correctly.

CAUTION: If you operate the valve near its temperature and/or pressure limit (very high or very low temperature and/or pressure), do the visual checks more frequently.

As well as the visual checks, schedule suitable maintenance intervals to AAR requirements.

Replacement Parts

Do not adapt or change the valve. If you install a replacement part, it must be a genuine Fort Vale part.

WARNING: If you install a part that is not a genuine Fort Vale part, there is a risk of:

- injury to personnel
- permanent damage to the valve
- permanent damage to the vessel
- valve malfunction.

External Fire

If the valve is installed in an area where there is a risk of external fire, you must install compatible accessories to prevent damage to the valve.

Compatibility of Accessories

Accessory components must cause no interference with the function of the valve. Accessory components must be made from compatible materials that will not cause damage to the valve.

Mis-use

Obey the instructions and recommended procedures in the installation and operating instructions. Obey the pressure and temperature markings on the valve and on the drawing. Use the valve/ancillary for its correct function only. Fort Vale accept no liability or responsibility for incorrect use of the valve/ancillary.

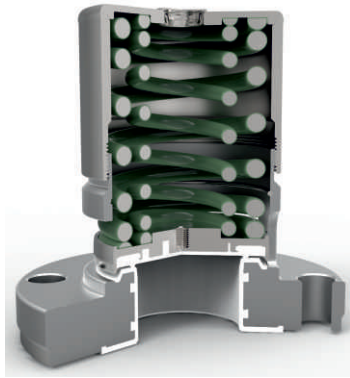

2.7"NB PFA Lined Super Maxi Pressure Only Rail Car Relief Valve - raised face flanged tank connection, drilled 4 holes 0.87" equi-spaced on a 6.25" PCD. Standard set pressure : 165 PSI (11.38 Bar) with Halar coated springs. Contact parts PFA lined.

Options - Alternative pressure settings are available.

Fitting Details

Part Number : 0U3/PXXX006R

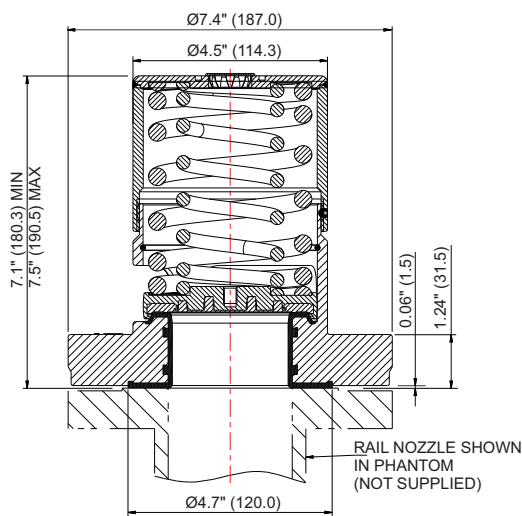

Specification

Weight 37.7 Lbs (17.1 Kg)
 Design Pressure (MAWP) 165 PSIG (11.38 Barg)
 Test Pressure 248 PSIG (17.1 Barg)
 Minimum Design Temperature -67°F (-55°C)
 Maximum Design Temperature 302°F (150°C)

AAR No: PRD139511

Certified full flow rate at 198 PSI : 22286.3 SCFM (120% over pressure)
 Certified full flow rate at 214.5 PSI : 24000 SCFM (130% over pressure)

Associated Parts

Conversion kit, part no: 0U3/0165K

To change 0U3/P165006R to 0U3/0165006R
 Refer to Fort Vale for information.

Parts drawing

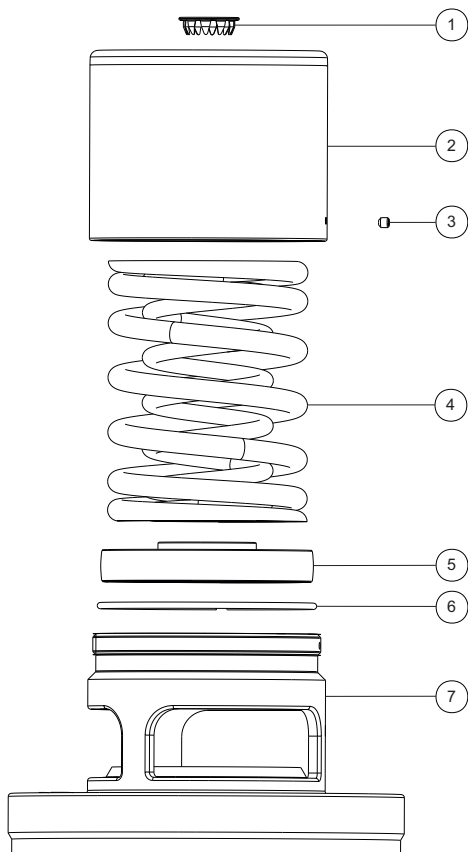

Item	Description	Part No.
1	Stainless steel plug	10978/1
2	Top cap	1860/0049/5
3	Grubscrew	5121-001
4	Halar® lined spring pair	See Table 1
5	PFA lined pressure plate	1860/P085
6	Retaining ring clip	5120-067
7	PFA lined body	1860/0635U

TABLE 1

Common Pressure Setting	Part number
165 PSI	6104-1264RL (Pair)

Other pressure settings are available - please contact Fort Vale.

PFA is a fluoropolymer which combines the best attributes of PTFE and FEP. It provides extended service in applications involving chemical, thermal and mechanical stress.

Properties :

- Chemically resistant to all common solvents
- Chemically inert
- Maintains mechanical strength at high temperatures
- Excellent low temperature resilience
- High permeation performance
- Excellent flame resistance



2.7" PFA Lined Super Maxi Rail Relief Valve

Part No: 0U3/XXXX006R



2.7"NB PFA Lined Super Maxi Pressure Only Rail Car Relief Valve

Tank connection

Raised face flange drilled 4x 0.87" holes equi-spaced on a 6.25" PCD.

Standard set pressure

165 PSIG (11.38 Bar)

Wetted areas materials

Body: PFA coated

Spring: Inconel ® X750

Pressure plate: 316 stainless steel/zirconium

Pressure O ring material

Viton A ® (Alternatives are available.)

Section View

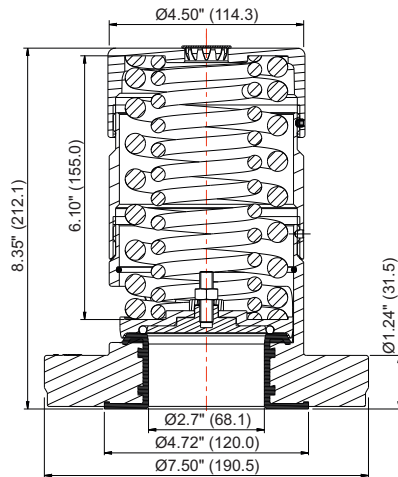

Design Conditions

Weight	26.2 Lb (11.9 Kg)
Cold Rating Pressure (CWP)	165 PSI (11.38 Bar)
Test Pressure	248 PSI (17.10 Bar)
Design Temperature min.	40°F (4°C)
Design Temperature max.	302°F (150°C)

AAR Application Number PRD 139511

NOTE: Design conditions and dimensions are for the specified part number only.

Certified full flow rate at 198 PSI:
22286.3 SCFM (120% over pressure)

Certified full flow rate at 214.5 PSI:
24000 SCFM (130% over pressure)

Parts Drawing

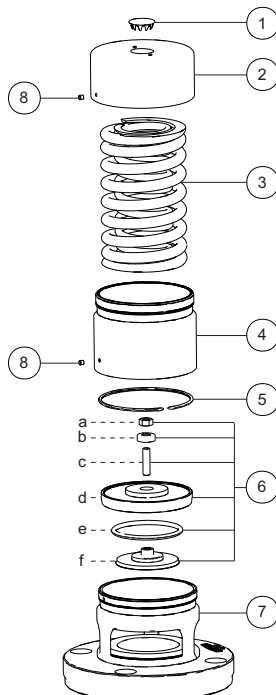

Parts List

Item	Description	Part No.
1	Stainless steel plug	10978/1
2	Top cap	1860/0041/949
3	Inconel ® spring pair	6104-1264RI
4	Extension tube	1860/0094
5	Retaining ring clip	5120-067
6	Composite pressure plate:	1860/V19148Z
a	5/16"UNF full nut	5112-019
b	Retaining washer	1860/0190/3
c	5/16"UNF stud	312/1018
d	Outer pressure plate	1860/019A48
e	Viton A ® O ring	ORB335VR/60
f	Inner pressure plate, zirconium	1860/0190/2Z
7	PFA lined body	1860/0635U
8	Set screw (2)	5121-001

Related Parts

Conversion kit, part no: 0U3/0165K

To change 0U3/P165006R to 0U3/0165006R
Includes items 1, 2, 3, 4, 6 & 8.



Part Number Breakdown - 0R3/XXXX006X

Data Sheet

Flanged High-Pressure Super Maxi Relief Valve: AAR Specification

Example:

0R3/ 0 075 00 6 T

Valve Type _____

- 0R3/** Stainless steel body & springs
- 0U3/** PFA coated wetted areas & Halar coated springs
- HR3/** Metal parts SB574 UNS10276 & Inconel springs

Seal Type _____

All materials are proprietary brand, where applicable

- 0** Viton A ®
- 1** Fortyt (FEP outer/silicone core)
- 3** Kalrez 6375 ®
- 4** Black Buna N (HNBR)
- 7** Perfluoroelastomer
- 9** EPDM
- A** Aflas ®
- B** Viton B ® (Dupont)
- C** Chemraz 505 ®
- D** White EPDM (Food grade)
- E** Viton GF-S ® (Trelleborg CS5350)
- F** Black Neoprene
- G** Viton GFLT ®
- H** Black EPDM (Trelleborg EP787)
- J** Fortyt (FEP outer/Viton core)
- K** Kalrez 1050LF ®
- N** White Neoprene (Food grade)
- P** PFA lined pressure plate
- S** Viton GF-S ® (Peroxide cured)
- T** Hi-temp. Fortyt (PFA outer/silicone core)
- U** Viton B ® (Trelleborg 4273B)
- W** White Buna N (Food grade)

Pressure Setting (PSIG) _____

- 075** 75 PSIG
- 165** 165 PSIG

Vacuum Setting _____

- 00** No vacuum

Bore Diameter _____

- 6** 2.70" (68.1mm)
- 7** 2.85" (72.5mm)

Flange Specification _____

- A** 8 holes on a 10.3" PCD - Raised face PFA coated - AAR Fig.E21 (A)
- J** 3 holes on a 5.50" PCD - Raised face PFA coated
- R** 4 holes on a 6.25" PCD - Raised face
- S** 8 holes on a 10.3" PCD - Tongue & groove
- T** 4 holes on a 6.25" PCD - Tongue & groove
- V** 8 holes on a 10.3" PCD - Raised face - AAR Fig. E21 (A)



Our subsidiaries are located in:

US Office

126 N. Virginia
La Porte
TX 77571
USA

Tel: +1 281 471 8100

Fax: +1 281 471 8116

Email: ussales@fortvale.com

Head Office

Calder Vale Park
Simonstone Lane
Simonstone, Burnley
Lancashire, BB12 7ND, UK

Tel: +44 (0) 1282 687120

Fax: +44 (0) 1282 687110

Email: sales@fortvale.com

China Office

Fort Vale Engineering Shanghai Ltd
Building 11 88 Yuanshan Road
Xinzhuang Industry Park
Shanghai 201108 China

Tel: +86 21 6442 1367

Fax: +86 21 6442 1376

Email: cnsales@fortvale.com

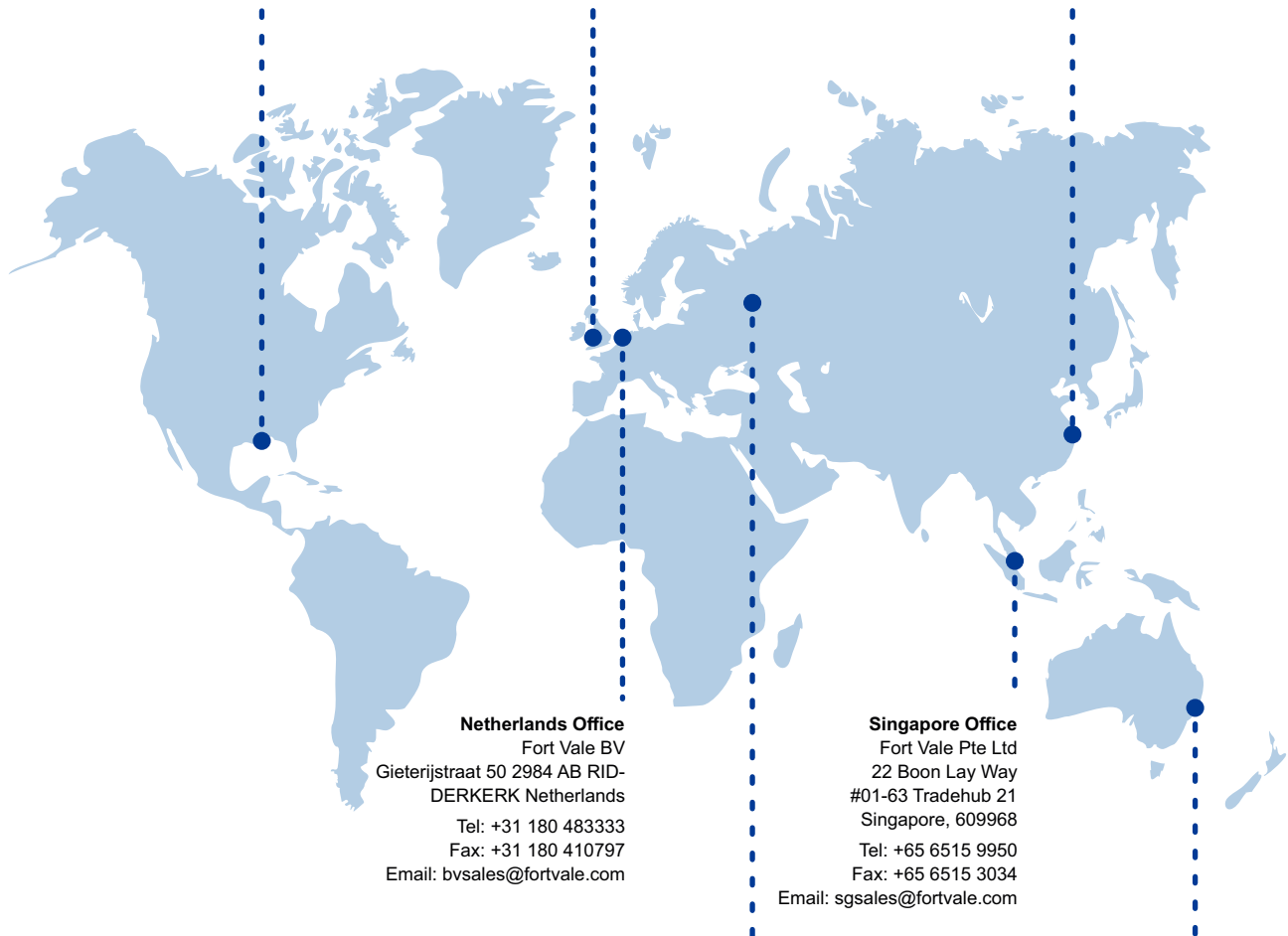

Netherlands Office

Fort Vale BV
Gieterijstraat 50 2984 AB RID-
DERKERK Netherlands

Tel: +31 180 483333

Fax: +31 180 410797

Email: bvsales@fortvale.com

Singapore Office

Fort Vale Pte Ltd
22 Boon Lay Way
#01-63 Tradehub 21
Singapore, 609968

Tel: +65 6515 9950

Fax: +65 6515 3034

Email: sgsales@fortvale.com

Russia Office

Fort Vale Russian Federation
3 Moskovski Shossee
Office 11, Sergeev Posad
Moscow Region 141304
Russian Federation

Tel: +7 916 682 0947

+7 926 538 7289

Email: rw@fortvale.ru

Australia Office

Fort Vale Australia Pty Ltd
9/38 Limestone St
Darra, Queensland, 4076

Tel: +61 7 3189 5059

Email: wmildenhall@fortvale.com

We also have Authorised Distributors around the world to provide you with product sales and after-market services. To find your nearest distributor, please visit our website - www.fortvale.com

